



QE-POWER-T

Three phase energy meter with universal current input

INTRODUCTION

Description

Three phase energy meter with universal current input: current transformers with output in voltage or in current can be used on the same inputs.
 One DIN box, perfect for electrical panel. Equipped with one serial output RS485 Modbus RTU for readings and one digital output for alarms. Configuration through free software.



Meter Characteristics

- Equivalent to class 0,5S (KWh) of EN62053-22
- Equivalent to class 0,5S (KVARh) of EN62053-24
- Accuracy $\pm 0,5\%$ RDG
- Universal input for current measurement
- Energy meter
- TRMS measurements of distorted sine waves (voltages/currents)
- Neutral current measurement
- One digital output (mosfet) for alarms
- Serial RS485 output
- Alarms signaling through front led
- Dimension: 1 DIN module
- Three variants available: Standard, Plus, Pro



Variants

Standard	Plus	Pro
$V_{RMS LL}$ e $V_{RMS LN}$ [V]	Distorted power factor	Harmonics up to 63rd order
I_{RMS} [A]	Tan ϕ	Interharmonics
Power: <ul style="list-style-type: none"> • Active [W] • Reactive [VAR] • Apparent [VA] 	Average, MAX and min: V_{LL} , V_{LN} , I, W, VAR, VA, Cos ϕ	Power quality: <ul style="list-style-type: none"> • Sag • Swell • Interruption
Cos ϕ	Phase sequence monitoring	Waveforms display through FACILE configuration software.
Crest Factor	Internal temperature [°C]	
Frequency [Hz]	MAX demand	Single phase device efficiency measurement
Peaks on: <ul style="list-style-type: none"> • Voltage V_{LL} [V] • Voltage V_{LN} [V] • Currents I [A] 	Time above given threshold for P_1 , P_2 , P_3 o P_{3PH}	
Energies (pos, neg, total): <ul style="list-style-type: none"> • Active [Wh] • Reactive [VARh] • Apparent [Vah] 	Inverter input (PWM modulated input)	
	THD, TDD	



GENERAL SPECIFICATION

Power supply specifications

AC/DC Voltage	10 - 40 V _{DC} 19 - 28 V _{AC}
Power consumption	< 0,7 W

Input specifications

Working frequency	1 - 70 Hz
Voltage	
Impedance	400 K Ω
Nominal voltage U _n	300 V _{LN} / 500 V _{LL}
Continuous overload U _{MAX}	400 V _{LN} / 700 V _{LL}
Overload for 500 ms	600 V _{LN} / 1000 V _{LL}
Current	
Type	Not isolated (external CTs necessary)
<i>Current output CTs</i>	
Nominal current I _n	5 A _{AC}
Crest factor	< 4 (20 A _{PK} MAX)
Impedance	< 0,5 VA per fase
Continuous overload I _{MAX}	6 A _{AC}
Overload for 500 ms	40 A _{AC}
<i>Voltage output CTs</i>	
Nominal voltage V _n	333 mV _{AC}
Crest factor	< 3 (1 V _{PK} MAX)
Impedance	220 K Ω
Continuous overload V _{MAX}	2,1 V _{PK}
Overload for 500 ms	13 V _{PK}
Accuracy (@ 25 \pm 5 $^{\circ}$ C; freq = 50 Hz)	
Frequency	\pm 0,1 Hz (40..70 Hz)
Active energy	class C according to EN50470-1/3 class 0,5 S according to EN62053-22
Reactive energy (if measured, see ahead)	class 0,5 S according to EN62053-24
Power factor	\pm (0,001 +1%(1,00-PF))
Bandwidth (-3dB)	> 2KHz
Thermal drift	<100 ppm/ $^{\circ}$ C
Energy backup	Via Flash, minimum lifetime: 3 years

Software functions

Measurement type	TRMS
Sampling rate	6400 samples/s @ 50Hz, 7280 samples/s @ 60Hz
Measurement refresh rate	Software configurable; Default: 50 AC cycles MAX: 65535 cycles



Transformer ratio	CT and VT default 1,0; software configurable
Transformer delay	0,0° @50 Hz default; software configurable
Minimum display cutoff	Configurable on voltage, current and power

Output specifications

RS485	
Baudrate	from 1200 to 115200 Baud (standard 9600)
Address	from 1 to 247
Protocol	Modbus RTU
Connection	Through 3 poles pluggable terminals (activated via software as an alternative to the digital output) or via T-Bus (always active)
Uscita digitale	
Use for	Alarms
Numbers	1 (activated via software as an alternative to the RS485)
Type	Solid state (Mosfet)
Max values	< 40 V, < 100 mA

General specifications

Operating temperature	-10°C... +60°C
Storage temperature	-40°C... +85°C
Humidity	10..90% not condensing
Altitude	Up to 2000 m s.l.m.
Installation category	Cat. III (IEC 60664, EN60664)
Isolation	4 KV _{RMS} between power supply and measuring inputs 4 KV _{RMS} between RS485 and measuring inputs 1,5 KV _{RMS} between power supply and RS485
Standards	
EMC / EMI	EN61000-6-4; EN61000-6-2; EN61000-4-2; EN61000-4-3; EN61000-4-4; EN61000-4-5 ; EN61000-4-6;
Safety	EN61010-1; EN61010-2-030;
Connections	n°1 removable terminals pitch 3,5 mm 2 poles n°1 removable terminals pitch 3,5 mm 3 poles n°1 removable terminals pitch 3,5 mm 6 poles n°1 removable terminals pitch 5.08 mm 4 poles
Housing	
Dimensions	93 x 17,7 x 68,3 mm (excluding terminal)
Material	PBT, gray
Dip-Switch	2 poles (for Baudrate and Address)
Protection degree IP	IP20
Mounting	Din rail mounting, designed for mounting on bus (connector not included)
Led	N°5: Power (Green), Fail (yellow), TX e RX (red), Digital output (Green)
Configuration	With software FACILE QE-POWER-T or via RS485 Modbus. Communication to free interface program for: - configuration of all the available parameters; - possibility of firmware upgrade (if available).



DIGITAL OUTPUT ALARMS

Rising: Normally open contact

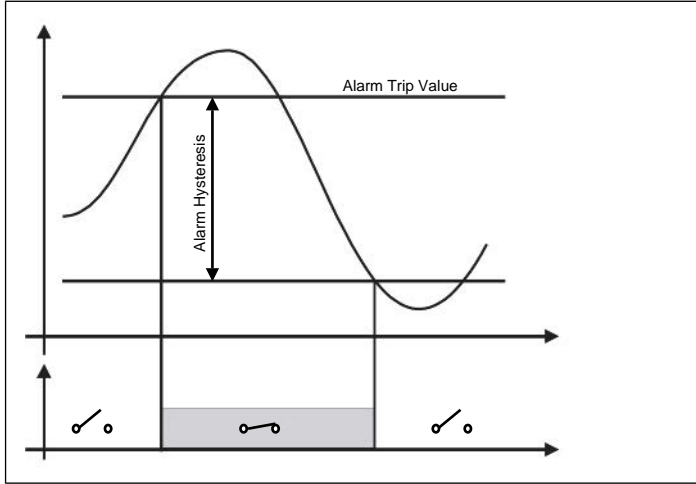

Falling: Normally closed contact

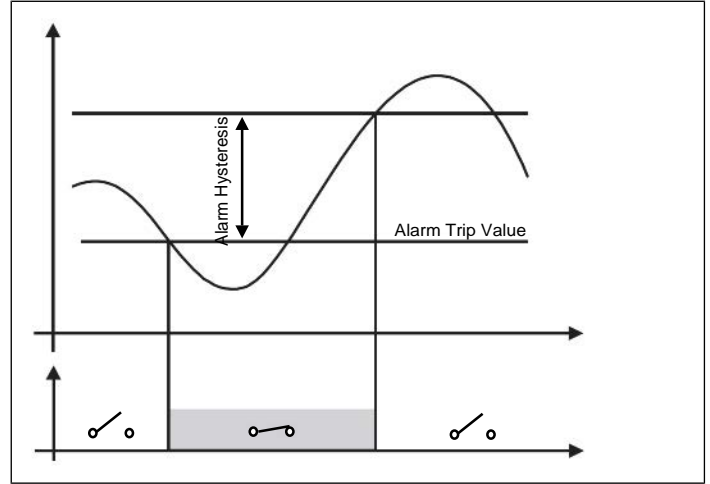

Windowed: closed contact between thresholds

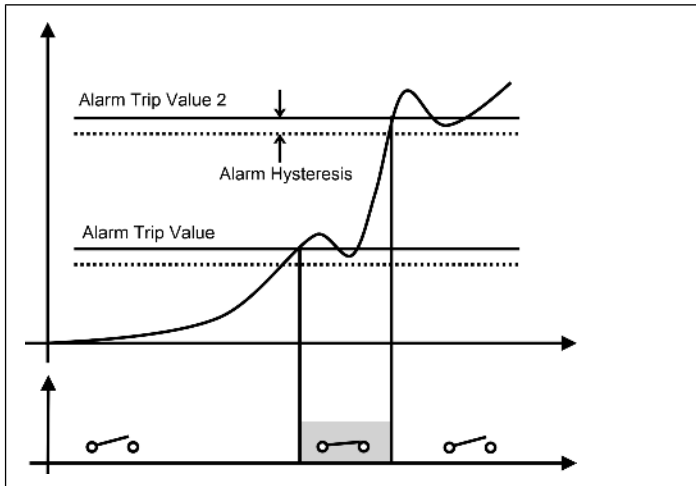

Windowed: closed contact outside thresholds

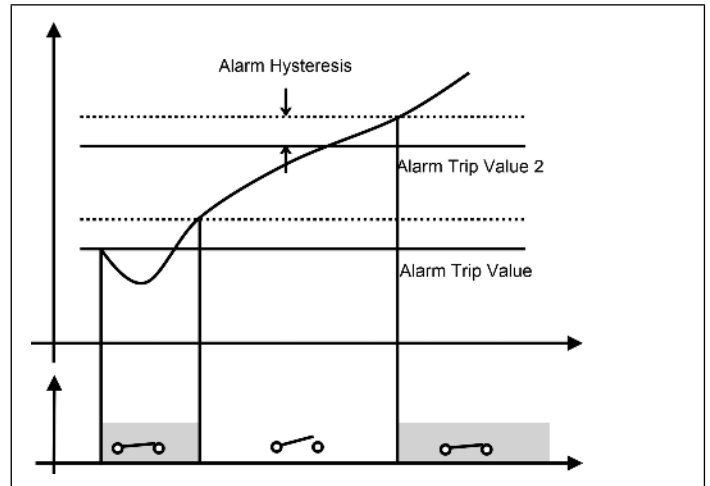

Note: To enable digital output alarms, RS485 terminals must be configured for digital output. Communication will be available only on T-BUS.

FRONTAL LEDS

Function	State	Note	
Power (green)	Steady on	Powered device	
Fail (yellow)	Blinking	<i>Bootloader active:</i> Can be executed through Modbus command, or because of program flash corruption.	
	Steady on	<i>At least one</i> of the following state is present:	
		Eeprom fail	Error on storing flash for settings, calibration or energies
		Phase reversal	Phase sequence L ₁ , L ₂ e L ₃ is not correct
		I _i or V _i over-range	Current or voltage phase i has a too high positive value
I _i or V _i under-range	Current or voltage phase i has a too high negative value		
RX (rosso)	Blinking	The device is receiving data from RS485	
TX (rosso)	Blinking	The device is sending data from RS485	
D _{out} (verde)	Steady on	Digital output is closed	



ADDITIONAL INFORMATION

ACCURACY (according to EN50470-3 and EN62053-24)

Wh, accuracy depending on the load (current output CT)

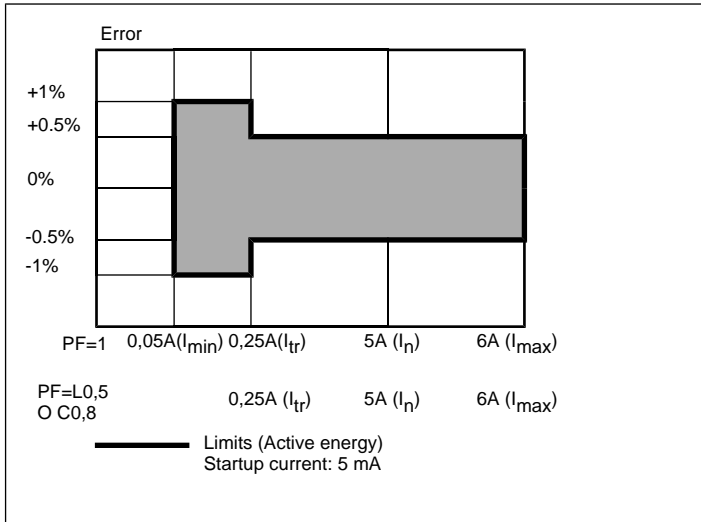

VARh, accuracy depending on the load (current output CT)

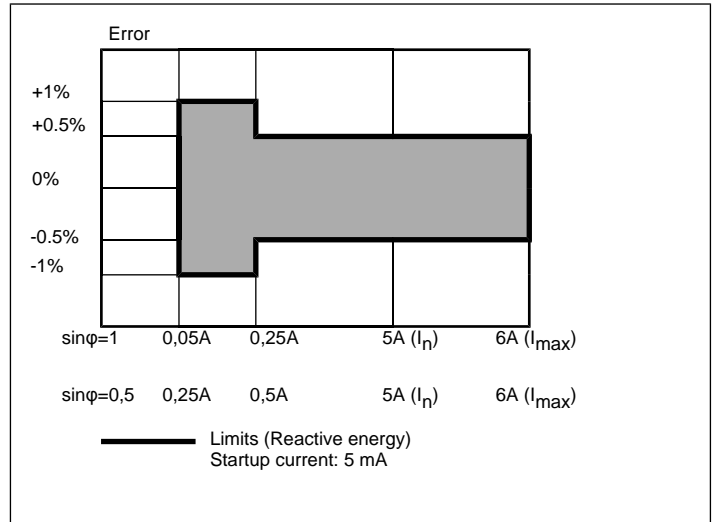

Wh, accuracy depending on the load (voltage output CT)

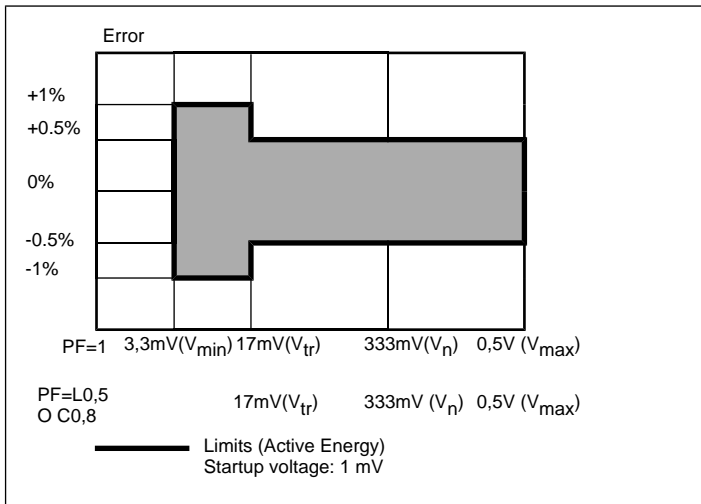

VARh, accuracy depending on the load (voltage output CT)

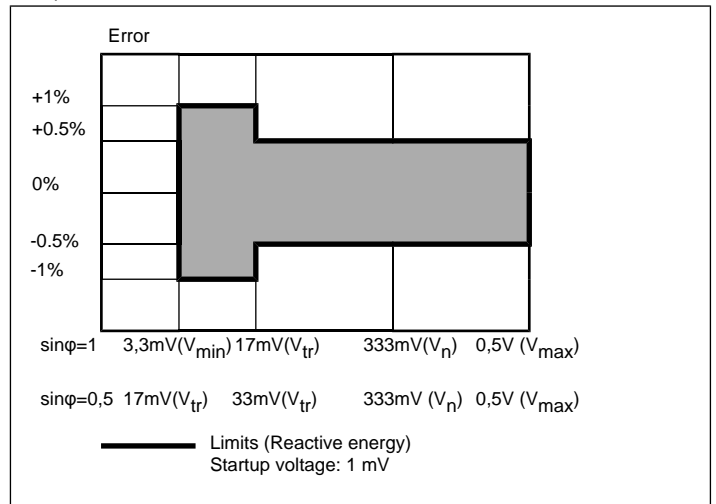

Note: Reactive power accuracy is granted if the instrument Q calculation is according Budeanu formula.

INSULATION BETWEEN INPUTS AND OUTPUTS

	Power supply	Measurement inputs	Communication port
Power supply		4 KV	1,5 KV
Measurement inputs	4 KV		4 KV
Communication port	1,5 KV	4 KV	



USED CALCULATION FORMULAS

Phase variables	System variables	Energy metering
<p>RMS Voltage</p> $V_i = \sqrt{\frac{1}{N} * \sum_1^N (v_L)_i^2}$	<p>Voltage average</p> $V_{AVG} = \frac{V_1 + V_2 + V_3}{3}$	<p>Active Energy</p> $Wh_i = \int_{t_1}^{t_2} P_i(t) dt \approx \Delta t \sum_{n_1}^{n_2} P(n)_i$
<p>RMS Current</p> $I_i = \sqrt{\frac{1}{N} * \sum_1^N (i_L)_i^2}$	<p>Current average</p> $I_{AVG} = \frac{I_1 + I_2 + I_3}{3}$	<p>Reactive Energy</p> $VARh_i = \int_{t_1}^{t_2} Q_i(t) dt \approx \Delta t \sum_{n_1}^{n_2} Q(n)_i$
<p>Active Power</p> $P_i = \frac{1}{N} * \sum_1^N v_{Li} * i_{Li}$	<p>Three phase active power</p> $P_{3PH} = P_1 + P_2 + P_3$	<p>Apparent Energy</p> $VAh_i = \int_{t_1}^{t_2} S_i(t) dt \approx \Delta t \sum_{n_1}^{n_2} S(n)_i$
<p>Apparent Power</p> $S_i = V_i * I_i$	<p>Three phase apparent power</p> $S_{3PH} = S_1 + S_2 + S_3$	<p>Where: i= phase observed (L1, L2 or L3); P= Active power; Q= Reactive power; t1, t2 = starting and ending time points of consumption recording; n= time unit; t= time unit length; n1, n2 = starting and ending discrete time points of consumption recording.</p>
<p>Reactive Power</p> $Q_i = \frac{1}{N} * \sum_1^N v_{Li} \hat{i}_{Li} \quad \text{Budeanu}$ $Q_i = \sqrt{S_i^2 - P_i^2} \quad \text{triangular}$	<p>Three phase reactive power</p> $Q_{3PH} = Q_1 + Q_2 + Q_3$	
<p>Power factor</p> $\cos \phi_i = \frac{P_i}{S_i}$	<p>Three phase power factor</p> $\cos \phi_{3PH} = \frac{P_{3PH}}{S_{3PH}}$	

DIP SWITCH SETTINGS

DIP 1	DIP 2	
0	X	RS485 settings from Eeprom
1	0	Address 1, Baudrate 9600, no parity
1	1	Address 1, Baudrate 38400, no parity

CONFIGURATION SOFTWARE

FACILE QE-POWER-T is the configuration software of the QE-POWER-T modules. It is free and downloadable from the website: <http://www.qeed.it/facile-qe-power-t/>
 To communicate with the module you have to connect via USB port directly on your PC. You can configure the module via RS485 using the map of the registers on the site www.qeed.it in the QE-POWER-T device page.



WIRING DIAGRAMS

3-ph, 4 wires, 3 CTs connection

Fig. 1

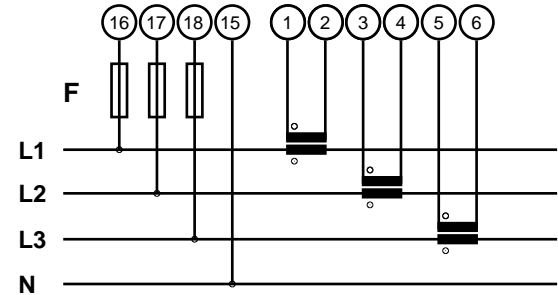

3-ph, 4 wires, 3 CTs and 3 VTs connection

Fig. 2

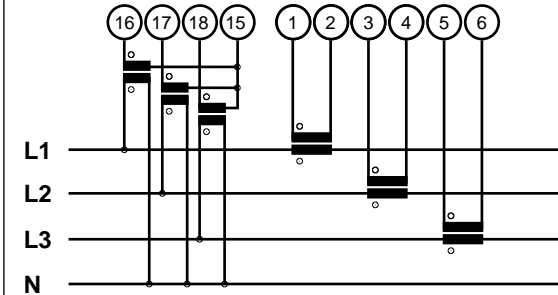

3-ph, 3 wires, 3 CTs connection

Fig. 3

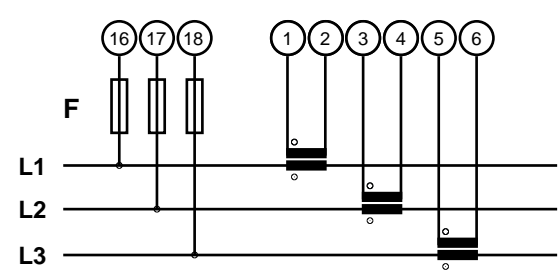

3-ph, 3 wires, 3 CTs and 3 VTs connection

Fig. 4

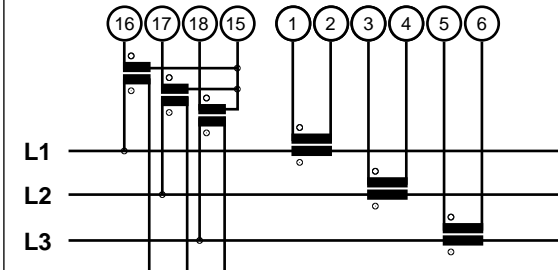

3-ph, 3 wires, 2 CTs connection (Aron)

Fig. 5

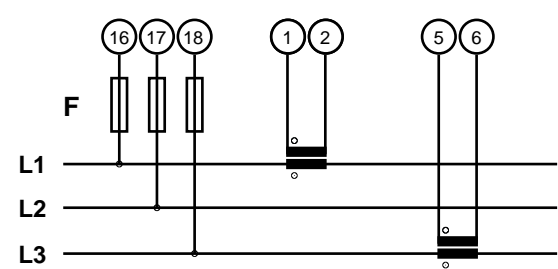

3-ph, 3 wires, 2 CTs 3 VTs connection (Aron)

Fig. 6

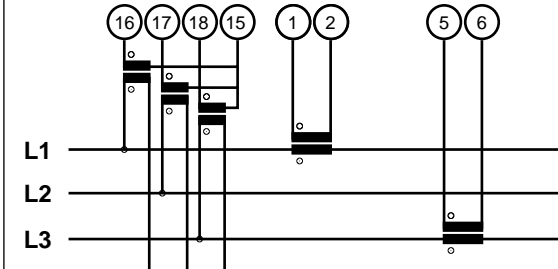

Monofase, 2 fili, connessione con 1 TA

Fig. 7

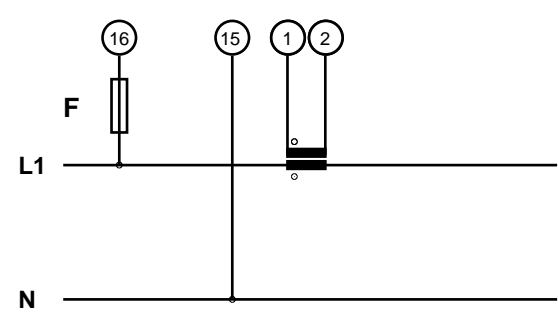

Monofase, 2 fili, connessione con 1 TA e 1 TV

Fig. 8

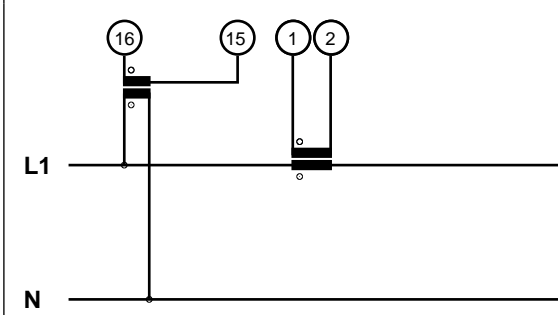

Digital output on terminal 8-9-10 in digital output configuration

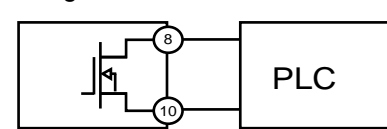

Power supply

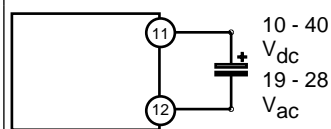

N.B.: Since this is a Class II device, as per "EN 61140:2004-05: Protection against electric shock – Common aspects for installation and equipment", it is forbidden the earthing of the device, to avoid damaging the device and reducing safety of the panel.

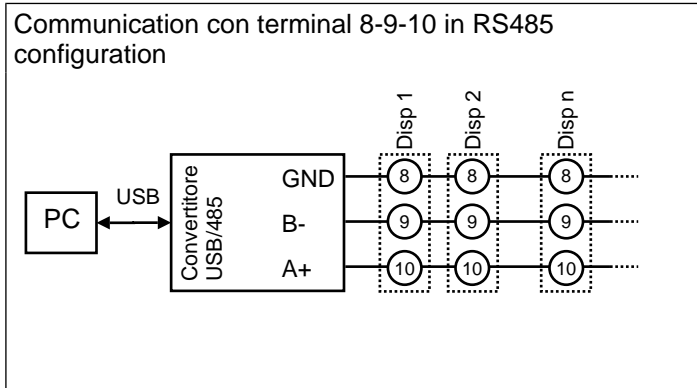
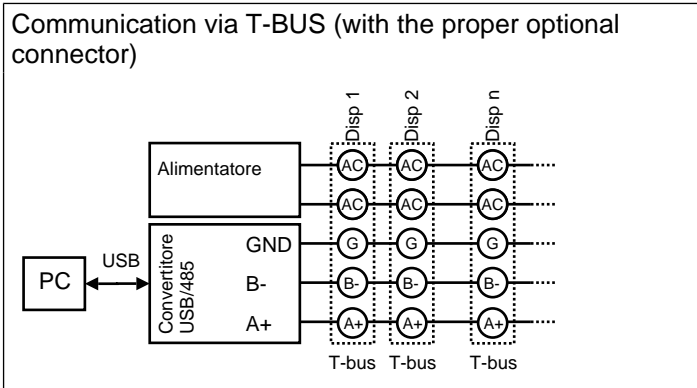

“CONFIGURATION REGISTER” 40007

This 16 bit register sets the configuration of the device. Hereafter the details

Settings	Valore	Dettaglio
CT input type	xxxx xxxx xxxx xxx0	Current input (e.g. CT 5A)
	xxxx xxxx xxxx xxx1	Voltage input (e.g. CT 333 mV, Rogowski)
Insertion handling	xxxx xxxx xxxx x00x	Single phase insertion
	xxxx xxxx xxxx x01x	Three phase insertion: three wires, 2 CTs (Aron)
	xxxx xxxx xxxx x10x	Three phase insertion: three wires, 3 CTs
	xxxx xxxx xxxx x11x	Three phase insertion: four wires, 3 CTs
FFT representation	xxxx xxxx xxxx 0xxx	Absolute: each harmonic RMS is displayed.
	xxxx xxxx xxxx 1xxx	Relative to First harmonic: X_n/X_1 is displayed.
Reactive power formula	xxxx xxxx xx0x xxxx	Triangular method: this method gives you an indirect reactive power measurement. It's the most used in energy meters.
	xxxx xxxx xx1x xxxx	Phase shifting method (Budeanu). This method measures reactive power directly. Accuracy is given with this method
8-9-10 terminal usage	xxxx xxxx x0xx xxxx	Used as RS485: 8 = GND, 9 = B-, 10 = A-
	xxxx xxxx x1xx xxxx	Used as digital output between terminal 8 e 10. Communication RS485 is still present on T-Bus connector.
Frequency channel	xxxx xxxx 0xxx xxxx	Voltage channel, L1 phase
	xxxx xxxx 1xxx xxxx	Current channel, L1 phase
Voltage input type	xxxx xxx0 xxxx xxxx	Standard load
	xxxx xxx1 xxxx xxxx	PWM input voltage.
Energy saving	xxxx xx0x xxxx xxxx	Saving disabled
	xxxx xx1x xxxx xxxx	Saving enabled
Dynamic data representation	xxx0 0xxx xxxx xxxx	Float
	xxx0 1xxx xxxx xxxx	Float swapped
	xxx1 0xxx xxxx xxxx	Integer = Float/100
	xxx1 1xxx xxxx xxxx	Integer swapped = Float/100
Integrator	xx0x xxxx xxxx xxxx	Disabled
	xx1x xxxx xxxx xxxx	Enabled, for Rogowski input
Digital output behaviour	x0xx x0xx xxxx xxxx	Rising: Normally open contact
	x1xx x0xx xxxx xxxx	Falling: Normally closed contact
	x0xx x1xx xxxx xxxx	Windowed: closed contact between thresholds
	x1xx x1xx xxxx xxxx	Windowed: closed contact outside thresholds
Filtering	0xxx xxxx xxxx xxxx	Filtering disabled: less stable but faster measurement
	1xxx xxxx xxxx xxxx	Filtering enabled: more stable but slower measurement